

DP C11.UART



CONTENT

Content.....	1	Button definition.....	7
Introduction.....	2	Normal operation.....	7
Overview drawing.....	3	Functions setting.....	10
Specifications.....	4	BESST connection.....	14
Functions overview.....	5	Error code definition.....	15
Normal indication area.....	6	Notes.....	16

INTRODUCTION

- Name: Intelligent display
- Model: DP C11.UART
- Scope: EN15194 electrically power assistance cycle
- Appearance: the shell is made of PC1414 in black/white; The liquid crystal display is made of hardened PMMA, the key button is made of silicone rubber.



- Number rule on the back of the display
Number on the middle of display back, number is divided into two lines:
A. Up line (as below)
DP C11.U 1.0
① DP C11.U: BAFANG display mode
② 1.0: hardware version number
B. Down line (as below)
607E1Q7280001
① 607: Wire length and connector model
is 750mm M5.2

- ② E1: design number
- ③ Q7280001: Production date is
28st July, 2016; SN is 0001

- Display P type wire label number rule
Number on the middle of P type label, number is divided into up row and down row and QR code is at right side (as shown in the below figure)

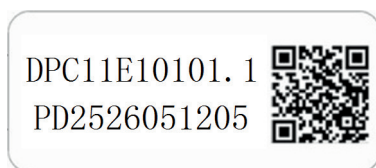

Content of QR code:

DPC11E10101.1
PD2526051205
DP C11.U 1.0
607E1Q7280001

The first line:

DPC11E10101.1 - Software version

The second line:

PD2526051205 - Parameter code

The last two lines:

DP C11.U 1.0 / 607E1Q7280001 - SN

OVERVIEW DRAWING



SPECIFICATIONS

- Rated voltage: 36V/43V/48V DC
- Rated current: 10mA
- Maximum operating current: 30mA
- When power off, leakage current: <1uA
- Operating current supplied to controller: 50mA
- Operation temperature: -20 °C~45 °C
- Storage temperature: -30 °C~70 °C
- IP level: IP65
- Storage humidity: 30%-70%

FUNCTIONS OVERVIEW

- Intelligent battery level indication: With an optimization algorithm, a stable display of the battery level is ensured, and the problem of fluctuant battery level indication common with other displays is avoided.
- Adjustment and indication of the power-assistance level
- Speed indication: Indicate the maximum speed and the average speed, unit can be changed between km and mile.
- Indicate the motor power
- Indicate the single riding time
- Trip distance indication: Single-trip distances trip, the total distance or remaining distance can be displayed.
- Walk assistance
- Indication and control of the headlight switch
- Check the battery information
- Indicate consumption of energy CALORIES (Note: need the controller support the function)
- Display remaining range (Note: If the controller has the function)

NORMAL INDICATION AREA

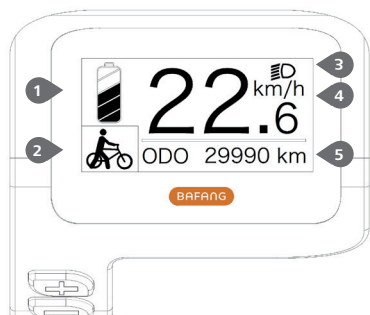





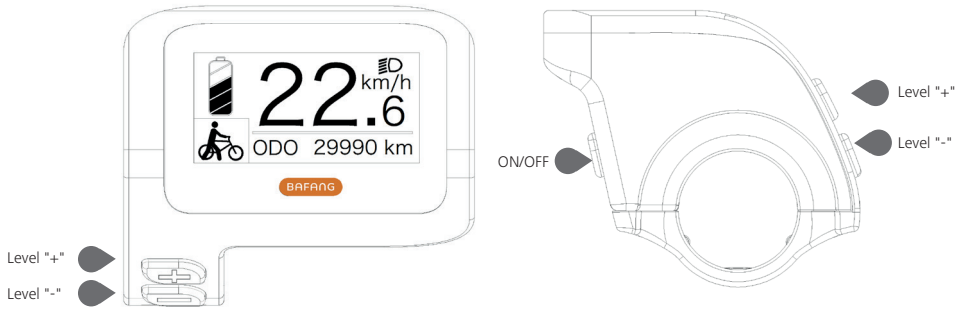

- 1 Battery level Indication:**
Indicate the current capacity level value.
- 2 Power-assistance level indication:**
Indicate the current level from level 0 to level 5. If no number is displayed, it means no power-assistance;  means at the mode of walk assistance.

- 3 Headlight/Backlight indication:**
Only display when headlight/backlight is on.
- 4 Indicate the current speed unit:**
km/h or MPH
- 5 Multi-function indication:**
Including single-trip distance TRIP, total distance ODO, maximum speed MAX, average speed AVG, remaining distance RANGE, output power POWER, Calorie Cal, riding time TIME. (Note: after switching on the display, within ten seconds, when detect the signal of torque sensor or detect it is the torque sensor, it display the calorie interface; if detect the remaining distance, it display the RANGE interface; or it will not display the two interface)

BUTTON DEFINITION



There are three buttons for C11, including power/mode key, plus key and minus key   . In the following the description, power key means  key, plus key means  key, minus key means  key.

NORMAL OPERATION

“Press and hold” means press and hold for more than two seconds, briefly press means press for less than 0.5 second.

- On/off

Press and hold power key, the display starts working. Press and hold the power key again, it will turn off. When power off, the display does not consume the power from the battery, because the leakage current is less than 1uA.

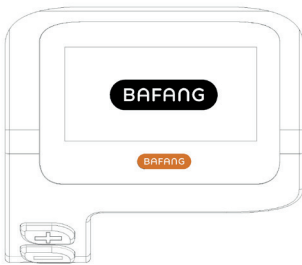

- Select power-assistance level

After starting up, briefly press the plus key or minus key to switch the power-assistance level to change the motor output power. Level 0 means no power assistance. Leave 1 is lowest level and level 5 is top level. After turning on the display, the default level is level 1.



- Headlight / backlight switch

Turn on the light: press and hold the “+” key, it will turn on the backlight of display and headlight, the display will show icon for the headlight. turn off the light: press and hold the “+”key again, it will turn off the backlight of display and headlight, and the icon for the headlight will disappear.

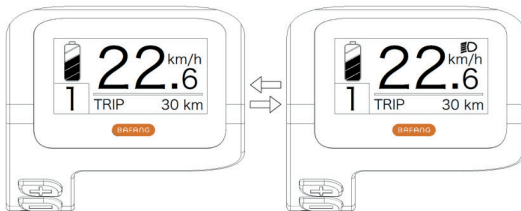

- The mode of walk assistance

Press and hold the “-” key, display will show the icon “” and the E-bike enter into the mode of walk assistance, release the “-” key, the icon disappear from the display and the E-bike exit the mode of walk assistance.



- Functional indications interface switch

The default interface is "TRIP" (single trip distance). it can circularly switch as "TRIP" (single trip distance) → "ODO"(total distance) → "MAX"(maximum riding speed) → "AVG"(average riding speed) → "RANGE"(remaining distance) → "CALORIES/CAL"(KCal) → "POWER"(output power) → "TIME"(riding time) → "TRIP"(single trip distance).

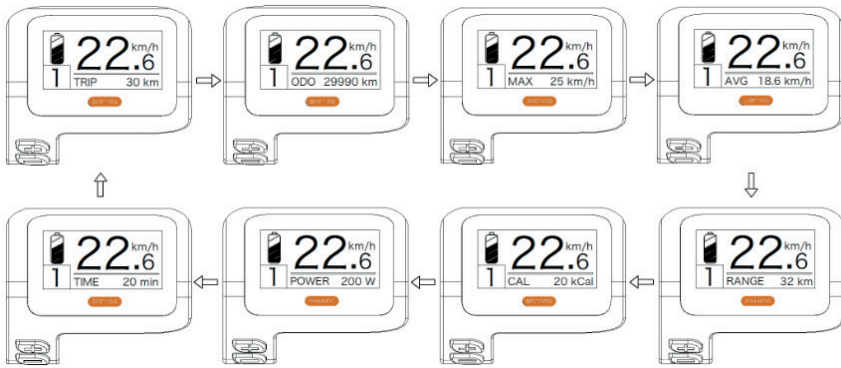

- State of charge indication for battery

It displays the state of charge for battery with one to five grids. When it display all five grids, it means the battery has full capacity. If the frame of the battery icon flickers at the frequency 1 HZ, it means battery needs to be charged immediately.

Battery icon Bars	State of charge	Icon diagram
5	75%-100%	
4	50%-75%	
3	30%-50%	
2	10%-30%	
1	5%-10%	
LOW	<5%	FLASH

FUNCTIONS SETTING

Press and hold “+” key & “-” key at the same time to enter into the menu list (“Display Setting”, “Information”, “EXIT”). Briefly press “+” key or “-” key to select “Display Setting”, “Information” or “EXIT”, and then briefly press the “power” key to select it.



Functional setting interface

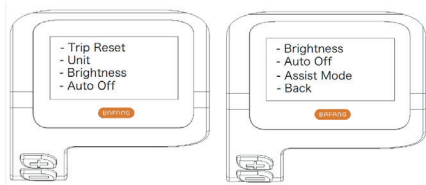

“Display Setting” interface

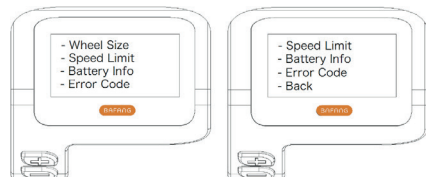

“Information” interface

1) Display setting

- Reset the single-trip distance

Enter into “Display Setting” menu and briefly press “+” key or “-” key to select “TRIP Reset” and briefly press “power” key. And then, briefly press “+” key or “-” key to select “NO”/“YES” (“YES” means reset, “NO” means no reset). Briefly press “power” key to save the setting and exit back to the “TRIP Reset”. Press and hold “+”&“-” at the same time to save and exit back to main interface or select “BACK”→“EXIT” to exit back to main interface.(note: after setting, pressing and holding “+” key and “-” key at the same time means saving setting and exiting back to main interface). When resetting the single-trip distance, it resets the riding time, average speed, maximum speed at the same time.



- Unit change between Metric and Imperial

Enter into “Display Setting” menu and briefly press “+” key or “-” key to select “Unit”, and then briefly press “power” key to confirm selection. Briefly press “+” key or “-” key to select “Metric”/“Imperial” and then briefly press “power” key to save the setting and exit back to “Unit”. Press and hold “+” key & “-” key at the same time to exit back main interface or select “BACK”→“EXIT” to exit main interface. (note: If selecting the metric

interface, the all information will be metric; if selecting the imperial, the all information will be imperial.)



- Backlight setting

Enter into "Display Setting" interface and briefly press "+" key or "-" key to select "Brightness" and then briefly press "power" key to confirm selection. Briefly press "+" key or "-" key to select as "100%" / "75%" / "50%" / "30%" / "10%". After selection, briefly press "power" key to save the setting and exit back to the "Brightness" interface. Press and hold "+" key and "-" key at the same time to exit back to main interface or select to "BACK" → "EXIT" to exit back to main interface.



- "auto off" time setting

Enter into "Display Setting" interface and briefly press "+" key or "-" key to select "Auto Off" and then briefly press "power" key to confirm selection. Briefly press "+" key or "-" key to select as "OFF" / "9" / "8" / "7" / "6" / "5" / "4" / "3" / "2" / "1". After selection, briefly press "power" key to save the setting and exit back to "Auto Off" interface. Press and hold "+" key and "-" key at the same time to exit back to main interface or select "BACK" → "EXIT" to exit back to main interface.

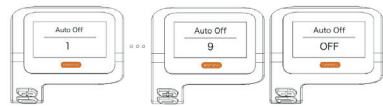

- Power-assistance mode setting

Enter into "Display Setting" interface and briefly press "+" key or "-" key to select "Assist Mode" and then briefly press "power" key to confirm setting. After setting, briefly press "+" or "-" to select as "3" / "6" / "9" and then briefly press "power" key to save the setting and exit back to the "Assist Mode" interface. Press and hold "+" key and "-" key to exit back to main interface or select "BACK" → "EXIT" to exit back to main interface. The default level for the display is level 5.



2) Indication information introduction

- Check wheel diameter

Enter into "Information" interface and briefly press "+" key or "-" key to select "Wheel Size" and then briefly press "power" key to check the wheel size.

Briefly press "power" key to exit back to "Information" interface. Press and hold "+" key and "-" key at the same time to exit back to main interface or select "BACK" → "EXIT" to exit back main interface.



- Check speed limit

Enter into "Information" interface and briefly press "+" key or "-" key to select "Speed Limit" and briefly press "power" key to check the speed limit. Briefly press "power" key again to exit back to "Information" interface. Press and hold "+" key and "-" key to exit back to main interface or select "BACK" → "EXIT" to exit back main interface.



- Check battery information

Enter into "Information" interface and briefly press "+" key or "-" key to select "Battery Info." And briefly press "power" to confirm selection. Briefly press "+" key, it display in turn b01 → b04 → b06 → b07 → b08 → b09 → b10 → b11 → b12 → b13 → d00 → d01 → d02 → ... → dn. briefly press "power" to exit back to "Battery Info." Press and hold "+" key and "-" key to exit back main interface or select "BACK" → "EXIT" to exit back to main interface.

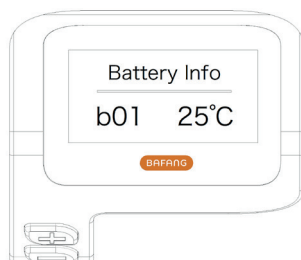

Code	Code definition	unit
b01	Current temperature	°C
b04	Total voltage	mV
b06	Average current	mA
b07	Remaining capacity	mAh
b08	Full charge capacity	mAh
b09	Relative SOC	%
b10	Absolute SOC	%
b11	Cycle	times
b12	Maximum not charging time	Hour

b13	Recently not charging time	Hour
d00	Number of battery cell	
d01	Voltage of cell 1	mV
d02	Voltage of cell 2	mV
...	...	mV
dn	Voltage of cell n	mV

- Check record of error code

Enter into "Information" interface and briefly press "+" key or "-" key to select "Error Code" and briefly press "power" key to check record. Briefly press "+" key to circularly display records of error code for latest ten times from "E-Code0" to "E-Code9". Briefly press "power" to exit back to "Information" interface or press and hold "+" key and "-" key to exit back to main interface.



BESST CONNECTION

- If it is successful for display to connect to BESST, the display will show: "Connected OK!".

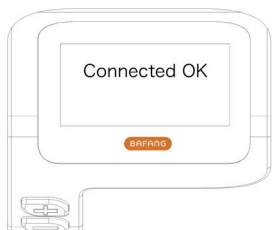

- When writing SN, if the display show "Write OK!", it means it is successful for BESST Tool to write SN into the display.



- If the display show "Read OK!" ,it means it is successful for BESST tool to read information from the display. The information includes customer's number, display type, wheel size, speed limit, software version and hardware version.

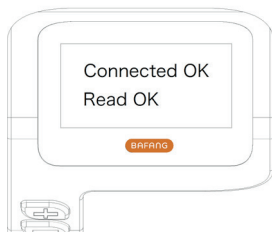

- When reading SN, if the display show "Read OK", it means it is successful for BESST Tool to read SN from the display.





- If the display show "Write OK", it means it is successful for BESST Tool to reset basic data into the display. The data includes customer's number, wheel size, speed limit.



- If display enters into test mode, it will switch to normal operation interface.



ERROR CODE DEFINITION

 DP C11.UART display can show e-bike faults. When a fault is detected, the icon  will be displayed. One of the following error codes will be displayed.

Error code	Error definition	Error-shooting method
"07"	High voltage protection	Check battery voltage
"08"	Fault with motor hall sensor inside	Check the motor module
"10"	The controller temperature reaches to the top protection value	Check the controller
"12"	Fault with current sensor inside controller	Check the controller
"13"	Fault with temperature sensor inside battery	Check the battery
"21"	Fault with wheel speed detecting sensor	Check the installation position of speed sensor
"22"	BMS communication fault	Replace the battery
"30"	Communication fault	Check the controller connection

NOTES
