

# 7 DEALER MANUAL FOR DP E160.CAN

---



## CONTENT

---

<b>7.1 Important Notice</b> .....	<b>2</b>	<b>7.7 Normal Operation</b> .....	<b>5</b>
<b>7.2 Introduction of Display</b> .....	<b>2</b>	7.7.1 Switching the System ON/OFF.....	5
<b>7.3 Product Description</b> .....	<b>3</b>	7.7.2 Selection of Support Levels.....	5
7.3.1 Specifications.....	3	7.7.3 Headlights / backlighting.....	5
7.3.2 Functions Overview.....	3	7.7.4 Walk Assistance.....	5
<b>7.4 Display Installation</b> .....	<b>3</b>	7.7.5 Battery Capacity Indication.....	6
<b>7.5 Display</b> .....	<b>4</b>	<b>7.8 Error Code Definition</b> .....	<b>7</b>
<b>7.6 Key Definition</b> .....	<b>4</b>		

# 7.1 IMPORTANT NOTICE

---

- If the error information from the display cannot be corrected according to the instructions, please contact your retailer.
- The product is designed to be waterproof. It is highly recommended to avoid submerging the display under water.
- Do not clean the display with a steam jet, high-pressure cleaner or water hose.
- Please use this product with care.
- Do not use thinners or other solvents to clean the display. Such substances can damage the surfaces.
- Warranty is not included due to wear and normal use and aging.

# 7.2 INTRODUCTION OF DISPLAY

---

- Model: DP E160.CAN BUS
- The housing material is PC+ABS and acrylic, as following:



- The label marking is as follows:



-  **Note:** Please keep the QR code label attached to the display cable. The information from the Label is used for a later possible software update.

## 7.3 PRODUCT DESCRIPTION

### 7.3.1 Specifications

- Operating temperature: -20 °C~45 °C
- Storage temperature: -20 °C~50 °C
- Waterproof: IP65
- Storage room Humidity: 30%-70% RH

### 7.3.2 Functional Overview

- Battery capacity indicator
- Indication of support level
- Walk assistance
- Automatic sensors explanation of the lighting system
- Indication for error messages
- Control and indication of lighting system

## 7.4 DISPLAY INSTALLATION

1. Open the clamp A on the display and place the display on to the handlebar in the correct position, where it is suitable for operation (the applicable handlebar are  $\varnothing 22.2\text{mm}$ ).

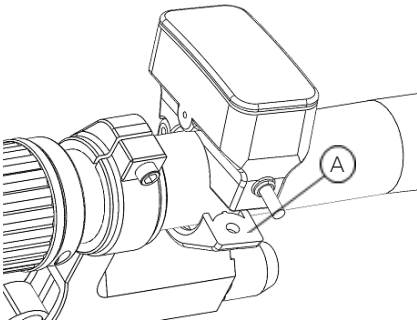

2. With the screw B (M3\*10 hexagon socket screw) tighten the display into position, torque requirement: 1N.m.

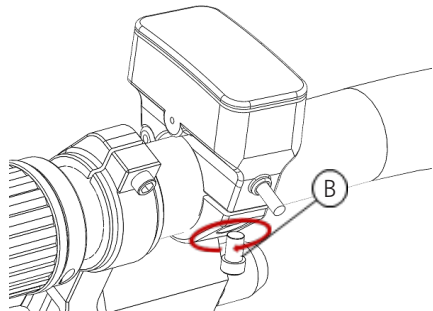

3. Please link the display to the EB-BUS cable.  
h: male connector at the display.  
H: female connector at the EB-BUS.

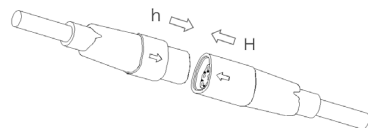

## 7.5 DISPLAY

---

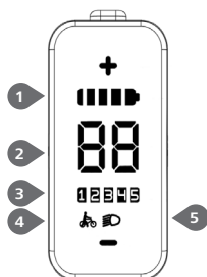

- 1 Battery capacity indicator
- 2 Speed indicator
- 3 Support level indicator
- 4 Walk assistance
- 5 Indicator for lighting system

## 7.6 KEY DEFINITION

---

E160 Display has three buttons: System On/Off  , Up  and Down  .

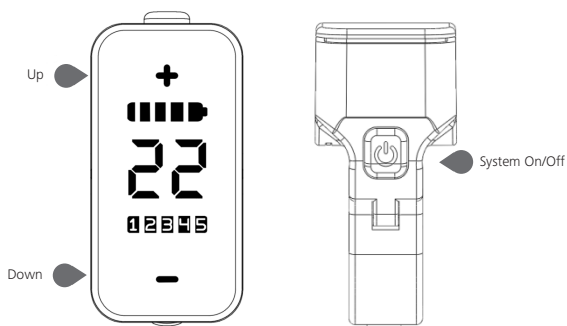

# 7.7 NORMAL OPERATION



## 7.7.1 Switching the System ON/OFF

Press and hold  (>2S) on the display to turn on the system.

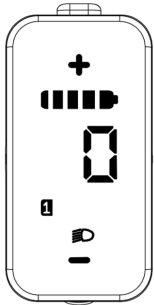
Press and hold  (>2S) again to turn off the system.



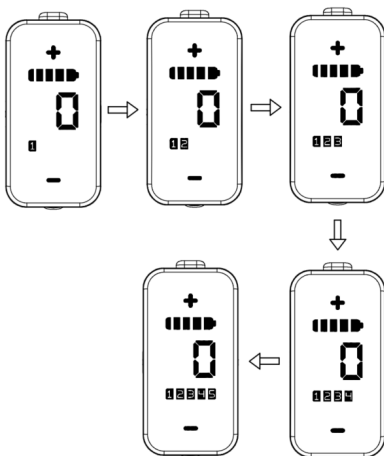

## 7.7.2 Selection of Support Levels

When the display is turned on, press the  or  (<0.5S) button to switch to the support level, the lowest level is 1, the highest level is 5. When the system is switched on, the support level starts in level 1. There is no support at level 0.





## 7.7.3 Headlights / backlighting

Hold the  (>2S) button to activate the headlight and taillights.

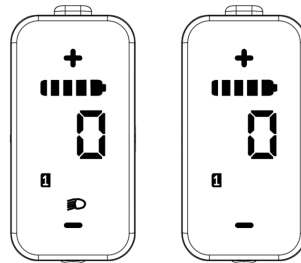
Hold the  (>2S) button again to turn off the headlight and taillight. (If the display is turned on in a dark environment, the display backlight/headlight will be turned on automatically. If the display backlight/headlight are turned off manually, they also need to be turned on manually afterwards)







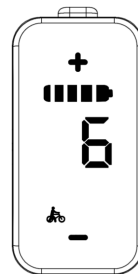

## 7.7.4 Walk Assistance

When your Pedelec is motionless, briefly press  button until the Walk assistance indicator  is displayed. At this point, long press  button, the Pedelec enters the walk assistance mode, the indicator will flash. If release the button will stop this, if no any operations within 5s will automatically return to 0 level. That is stopped from the Walk assistance mode.(as following)



### 7.7.5 Battery Capacity Indication

The battery capacity is indicated with 5 levels. When the lowest level indicator flashes that means battery needs to charge. The battery capacity is shown as follows:

Indication definition	SOC	Example
5 bars	80%-100%	
4 bars	60%-80%	
3 bars	40%-60%	
2 bars	20%-40%	
1 bar	5%-20%	
1 flashing	<5%	

## 7.8 ERROR CODE DEFINITION

The ebike system's parts are automatically monitored in real time. If a part is abnormal, the corresponding error code is displayed on the HMI. The E160.CAN flashes the code at a frequency of 1 Hz.



The troubleshooting methods in the list are listed in order according to the fault probability and the operability of the related parts. In practice, dealers can adjust the order based on the existing tools and spare parts. (For detailed disassembly steps, please refer to the dealer manual of the corresponding parts on the official website. <[www.bafang-e.com](http://www.bafang-e.com)>)



In order to protect the electric parts, before disassembling the parts, please switch off the system power first by pressing the control unit of HMI and then disconnect the power cable of the disassembled part. When installing the parts, please fix the parts first, then connect the power cable of the parts, and finally switch on the system power by pressing the control unit of HMI.



Please contact Bafang after-sale service personnel <[service@bafang-e.com](mailto:service@bafang-e.com)> if the above troubleshooting fails to solve the problem or the error code is not in the above list.

Code	Cause	Troubleshooting	
		Hub Motor System	Mid Motor System
05	Throttle not in place	<ol style="list-style-type: none"> <li>1. Check whether the throttle is in place.</li> <li>2. Check whether the throttle cable is connected correctly or the cable (from throttle to controller) is damaged.</li> <li>3. Troubleshoot the faulty part:               <ol style="list-style-type: none"> <li>1) Replace the throttle</li> <li>2) Replace the controller</li> </ol> </li> </ol>	<ol style="list-style-type: none"> <li>1. Check whether the throttle is in place.</li> <li>2. Check whether the throttle cable is connected correctly or the cable (from throttle to drive unit) is damaged.</li> <li>3. Troubleshoot the faulty part:               <ol style="list-style-type: none"> <li>1) Replace the throttle</li> <li>2) Replace the drive unit</li> </ol> </li> </ol>
07	System overvoltage protection	<ol style="list-style-type: none"> <li>1. Check whether the nominal voltage of the battery is the same as the controller.</li> <li>2. Troubleshoot the faulty part:               <ol style="list-style-type: none"> <li>1) Replace the battery</li> <li>2) Replace the controller</li> </ol> </li> </ol>	<ol style="list-style-type: none"> <li>1. Check whether the nominal voltage of the battery is the same as the drive unit.</li> <li>2. Troubleshoot the faulty part:               <ol style="list-style-type: none"> <li>1) Replace the battery</li> <li>2) Replace the drive unit</li> </ol> </li> </ol>
08	Hall signal in motor is abnormal	<ol style="list-style-type: none"> <li>1. Check whether the motor cable is connected correctly or the cable (from motor to controller) is damaged.</li> <li>2. Troubleshoot the faulty part:               <ol style="list-style-type: none"> <li>1) Replace the motor</li> <li>2) Replace the controller</li> </ol> </li> </ol>	Replace the drive unit

Code	Cause	Troubleshooting	
		Hub Motor System	Mid Motor System
09	Phase wire in motor abnormal	<ol style="list-style-type: none"> <li>1. Check whether the motor cable is connected correctly or the cable (from motor to controller) is damaged.</li> <li>2. Troubleshoot the faulty part: <ol style="list-style-type: none"> <li>1) Replace the motor</li> <li>2) Replace the controller</li> </ol> </li> </ol>	Replace the drive unit
10	Motor overtemperature protection (Only occur when the motor is equipped with the temperature sensor.)	<ol style="list-style-type: none"> <li>1. If riding for a long time, turn off the system and let the motor cool down.</li> <li>2. If no ride or riding for a short time, troubleshoot the faulty part: <ol style="list-style-type: none"> <li>1) Replace the motor</li> <li>2) Replace the controller</li> </ol> </li> </ol>	<ol style="list-style-type: none"> <li>1. If riding for a long time, turn off the system and let the drive unit cool down.</li> <li>2. If no ride or riding for a short time, replace the drive unit.</li> </ol>
11	Motor temperature sensor abnormal (Only occur when the motor is equipped with the temperature sensor.)	<ol style="list-style-type: none"> <li>1. Check whether the motor cable is connected correctly or the cable (from motor to controller) is damaged.</li> <li>2. Troubleshoot the faulty part: <ol style="list-style-type: none"> <li>1) Replace the motor</li> <li>2) Replace the controller</li> </ol> </li> </ol>	Replace the drive unit
12	Controller current sensor abnormal	Replace the controller	Replace the drive unit
14	Controller overtemperature protection	<ol style="list-style-type: none"> <li>1. If riding for a long time, turn off the system and let the controller cool down.</li> <li>2. If no ride or riding for a short time, replace the controller.</li> </ol>	<ol style="list-style-type: none"> <li>1. If riding for a long time, turn off the system and let the drive unit cool down.</li> <li>2. If no ride or riding for a short time, replace the drive unit.</li> </ol>
15	Controller temperature sensor abnormal	Replace the controller	Replace the drive unit



Code	Cause	Troubleshooting	
		Hub Motor System	Mid Motor System
21	Speed sensor abnormal	<ol style="list-style-type: none"> <li>1. Check whether the motor cable is connected correctly or the cable (from motor to controller) is damaged.</li> <li>2. Troubleshoot the faulty part:               <ol style="list-style-type: none"> <li>1) Replace the motor</li> <li>2) Replace the controller</li> </ol> </li> </ol>	<ol style="list-style-type: none"> <li>1. Check whether the spoke magnet has fallen off or the clearance between the spoke magnet and the speed sensor is within the normal range (10-15mm).</li> <li>2. Check whether the speed sensor cable is connected correctly or the cable (from sensor to drive unit) is damaged.</li> <li>3. Troubleshoot the faulty part:               <ol style="list-style-type: none"> <li>1) Replace the speed sensor</li> <li>2) Replace the drive unit</li> </ol> </li> </ol>
26	Torque sensor abnormal (Only occur when the drive system is equipped with the torque sensor.)	<ol style="list-style-type: none"> <li>1. Check whether the torque sensor cable is connected correctly or the cable (from sensor to controller) is damaged.</li> <li>2. Troubleshoot the faulty part:               <ol style="list-style-type: none"> <li>1) Replace the torque sensor</li> <li>2) Replace the controller</li> </ol> </li> </ol>	Replace the drive unit
30	Communication abnormal	<ol style="list-style-type: none"> <li>1. Check whether the HMI cable is connected correctly or the cable (from HMI to controller) is damaged.</li> <li>2. Troubleshoot the faulty part:               <ol style="list-style-type: none"> <li>1) Replace the controller if the HMI turns off automatically after appearing error code for 20 seconds.</li> <li>2) Replace the HMI if the HMI doesn't turn off automatically after appearing error code for 20 seconds. (move to the next page)</li> </ol> </li> </ol>	<ol style="list-style-type: none"> <li>1. Check whether the HMI cable is connected correctly or the cable (from HMI to drive unit) is damaged.</li> <li>2. Troubleshoot the faulty part:               <ol style="list-style-type: none"> <li>1) Replace the drive unit if the HMI turns off automatically after appearing error code for 20 seconds.</li> <li>2) Replace the HMI if the HMI doesn't turn off automatically after appearing error code for 20 seconds. (move to the next page)</li> </ol> </li> </ol>

Code	Cause	Troubleshooting	
		Hub Motor System	Mid Motor System
30	Communication abnormal	3) If the BESST tool is available, connect it with HMI and controller, read the information of HMI and controller and replace the part that cannot read information.	3) If the BESST tool is available, connect it with HMI and drive unit, read the information of HMI and drive unit and replace the part that cannot read information.
36	ON/OFF Button detection circuit abnormal (Only occur when the drive system is equipped with Bafang CAN communication protocol.)	1. If keep pressing the ON/OFF button when the HMI powers on, the error code will alarm. Release the button and observe whether the code disappears. 2. Troubleshoot the faulty part: 1) Replace the HMI 2) Replace the controller	1. If keep pressing the ON/OFF button when the HMI powers on, the error code will alarm. Release the button and observe whether the code disappears. 2. Troubleshoot the faulty part: 1) Replace the HMI 2) Replace the drive unit
37	WDT (Watch Dog Timer) in controller is abnormal	Replace the controller	Replace the drive unit
42	Discharge voltage of battery pack is too low	1. Charge the battery 2. Replace the battery	
49	Discharge voltage of single cell is too low	1. Charge the battery 2. Replace the battery	
4C	Voltage difference between single cell	Replace the battery	



The battery error codes of 42, 49, 4C only occur when the drive system is equipped with the smart BMS and Bafang CAN communication protocol.