

User's Manual

SHIMANO

Clamp Band Type Cycle Computer

Check our website for the latest manuals.

<https://si.shimano.com>



Contents



IMPORTANT NOTICE	3
Important safety information	4
SHIMANO STEPS battery management systems and compatibility	5
Notice	6
Regular inspections before riding the bicycle	8
Booklet structure	9
Names and functions of parts	10
Names and functions of parts	10
Notation method for operations	11
Installing and removing the cycle computer	12
Installing and removing the cycle computer	12
Basic operation	13
Turning the power ON/OFF	13
Viewing the screen.....	13
Turning the light ON/OFF	16
Switching to the sub screen	16
Setting menu	19
Switching to the setting menu.....	19
Exiting the setting menu [Exit]	19
Setting the time [Clock].....	19
Dynamically changing the riding comfort [Assist Profile]	21
Setting the display	24
Setting the assist bicycle function	25
Troubleshooting	28
Gear shifting adjustment with the electronic gear shifting unit [Adjust].....	28
When gear shifting is impossible	28
Error/warning indication	28
When a problem occurs.....	29

IMPORTANT NOTICE

- Contact the place of purchase or a distributor for information on installation, adjustment, and replacement of the products which are not found in the user's manual. A dealer's manual for professional and experienced bicycle mechanics is available on our website (<https://si.shimano.com>).
- Please observe the appropriate rules and regulations of the country, state or region in which you conduct your business as a dealer.
- The Bluetooth[®] word mark and logos are registered trademarks owned by the Bluetooth SIG, Inc. and any use of such marks by SHIMANO INC. is under license.
Other trademarks and trade names are those of their respective owners.

For safety, be sure to read this user's manual thoroughly before use, and follow it for correct use.

The following instructions must be observed at all times in order to prevent personal injury and physical damage to equipment and surroundings.
The instructions are classified according to the degree of danger or damage which may occur if the product is used incorrectly.

	DANGER	Failure to follow the instructions will result in death or serious injury.
	WARNING	Failure to follow the instructions could result in death or serious injury.
	CAUTION	Failure to follow the instructions could cause personal injury or physical damage to equipment and surroundings.

Important safety information

WARNING

- Do not disassemble or modify the product. This may cause the product to not operate correctly, and you may suddenly fall and be seriously injured.
- Riding precautions
 - Do not pay excessive attention to the cycle computer display while riding. Doing so may result in an accident.
 - Ensure that head and tail lights can turn on before riding the bicycle.
 - Safety precautions
 - Be sure to remove the battery and charging cable before wiring or attaching parts to the bicycle. Failure to do so may cause an electric shock.
 - Be sure to follow the instructions provided in the manuals when installing the product. Only use SHIMANO genuine parts. If a component or replacement part is incorrectly assembled or adjusted, it can lead to component failure and cause the rider to lose control and crash.

CAUTION

- Riding precautions
 - Observe the instructions in the manual for the bicycle in order to ride safely.
- Safety precautions
 - Never modify the system. Doing so may cause a system error.
 - Use the product under the supervision of someone responsible for safety, and only as instructed. Do not allow anyone (including children) with reduced physical, sensual, or mental capacity, or those without experience or knowledge, to use the product.
 - Do not allow children to play near the product.

SHIMANO STEPS battery management systems and compatibility

There are two generations of the SHIMANO STEPS battery management system: first generation and second generation (Gen.2).

This manual only describes products compatible with Gen.2.

With some exceptions, first-generation and Gen.2 products of SHIMANO STEPS components are not compatible with each other. For details, refer to the compatibility information on the SHIMANO product website (<https://productinfo.shimano.com/#/com>).

The Gen.2 battery and compatible battery mount are marked "Gen.2" as indicated in the figure.

Location of terminals

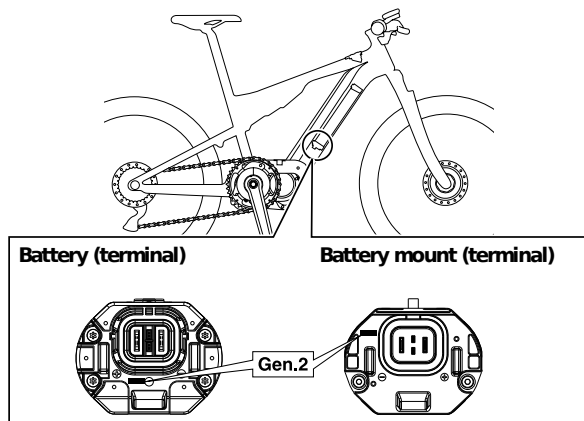

Notice

■ Safety precautions

- If any malfunction or trouble occurs, consult the place of purchase nearest you.
- For any questions regarding methods of installation and maintenance, please contact your place of purchase.
- Be sure to attach dummy plugs to any unused E-TUBE ports.
- For installation and adjustment of the product, consult the place of purchase.
- The components are designed to be fully waterproofed to withstand wet weather riding conditions; however, do not deliberately place them into water.
- Do not clean the bicycle in a high-pressure wash. If water gets into any of the components, operating problems or corrosion may result.
- Do not turn the bicycle upside down. There is a risk of damage to the cycle computer and switch unit.
- Handle the components carefully, and avoid subjecting them to strong shock.
- Although the bicycle still functions as a normal bicycle even when the battery is removed, the light will not turn on if it is connected to the electric power system. Be aware that using the bicycle under these conditions will be considered non-observance of the road traffic laws in Germany.
- Contact the place of purchase for updates of the component software. The most up-to-date information is available on the SHIMANO website.
- Products are not guaranteed against natural wear and deterioration from normal use and aging.
- For maximum performance we highly recommend SHIMANO lubricants and maintenance products.

■ Care and maintenance

- Do not use the thinners or harsh solvents to clean the products. Such solvents may damage the surface. When cleaning the products, use a cloth moistened with a neutral detergent diluted with water.

■ Labels

- Some of the important information contained in this manual is also indicated on the device label.

This device complies with part 15 of the FCC Rules. Operation is subject to the following two conditions:
(1) This device may not cause harmful interference, and (2) this device must accept any interference received, including interference that may cause undesired operation.

Notice



This symbol on your product, literature, or packaging reminds you that this product must be taken to separate collection at the end of its working life. Do not dispose of this product as unsorted municipal waste but instead take it for recycling. By ensuring the product is disposed correctly, you will help to prevent potential negative consequences for the environment and human health. For info on your nearest recycling point, check with your local waste authority.

Regular inspections before riding the bicycle

Before riding the bicycle, check the following items. If any problems are found, consult your place of purchase or a distributor.

- Does the drivetrain perform gear shifting smoothly?
- Is there any looseness or damage in the component parts?
- Are the components securely installed to the frame/handlebar/stem, etc.?
- Do any abnormal noises occur while riding?
- Is there sufficient charge remaining in the battery?

Booklet structure

SHIMANO STEPS user's manuals are split among several booklets, as described below.

Be sure to read these user's manuals thoroughly before use, and follow them for correct use. Store the user's manuals so that they can be referenced at any time.

The latest user's manuals are available on our website (<https://si.shimano.com>).

Name	Details
SHIMANO STEPS User's Manual	<p>This is the basic user's manual for SHIMANO STEPS. It contains the following content:</p> <ul style="list-style-type: none"> • SHIMANO STEPS quick guide • Basic operations when riding • How to operate assist bicycles that use flat handlebars, such as city, trekking, or MTB type bicycles
SHIMANO STEPS User's Manual for Drop Handlebar Bicycles (separate booklet)	<p>This booklet describes how to operate assist bicycles that use a drop handlebar and are controlled using dual control levers. This should be read along with the SHIMANO STEPS User's Manual.</p>
SHIMANO STEPS Special Battery and Parts User's Manual (Gen.2)	<p>It contains the following content:</p> <ul style="list-style-type: none"> • How to charge and handle the SHIMANO STEPS special battery • How to attach and remove the SHIMANO STEPS special battery to the bicycle • How to read the battery LEDs when charging or during an error
SHIMANO STEPS Cycle Computer User's Manual (clamp band type / bracket installation type / switch unit integrated type)	<p>It contains the following content:</p> <ul style="list-style-type: none"> • Method for configuring settings via the main body buttons and switch unit • Wireless communication method (supported models only)
Switch Unit User's Manual (with LED indicator function / without LED indicator function)	<p>This is the assist switch and shift switch user's manual. It describes switch unit handling and operations.</p>
Satellite System ON/OFF Switch User's Manual	<p>It describes the handling and operations of the satellite system ON/OFF switch.</p>

Names and functions of parts

Names and functions of parts

This product is secured to the handlebar with a clamp band or incorporated in the handlebar, depending on the bicycle. This product is operated with the switch unit included in the assist bicycle.

Clamp band type cycle computer

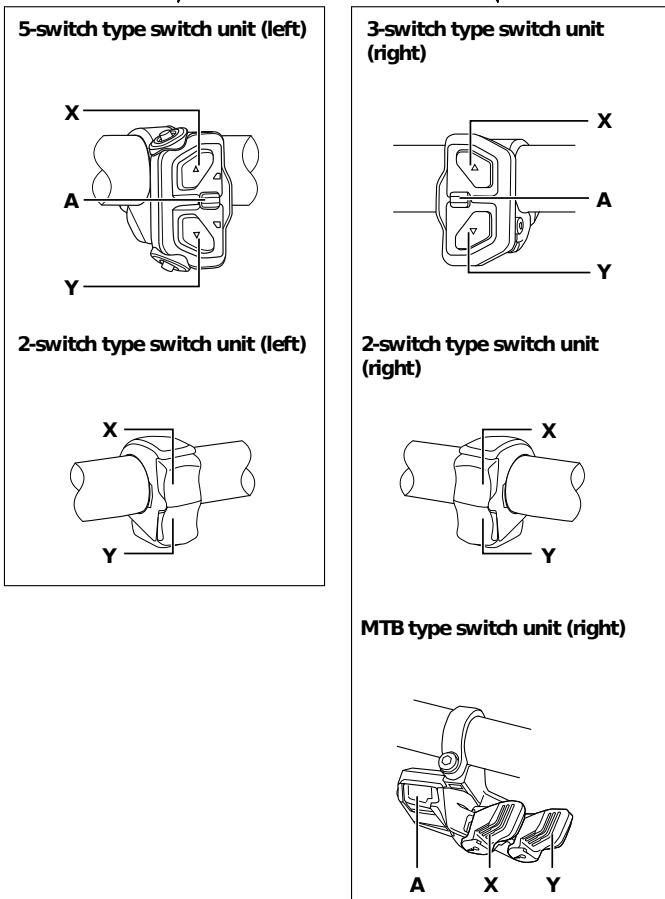
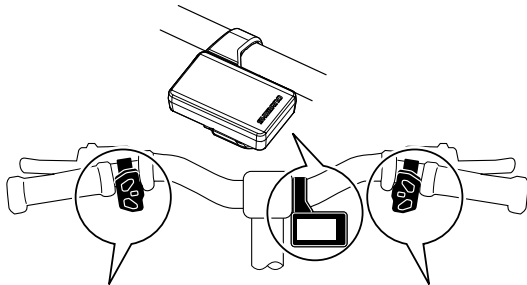

The operation for each switch is indicated below.

Switch unit (left)

Names and functions of parts

Notation method for operations

X	When riding : Increase the level of assistance When setting : Move cursor or change setting
Y	When riding : Decrease the level of assistance When setting : Move cursor or change setting
A	When riding : Switch between the main screen / sub screen When setting : Switch screen / confirm setting changes

Switch unit (right)

X	When riding : Shifting up (3-switch / 2-switch type) Shifting down (MTB type)
Y	When riding : Shifting down (3-switch / 2-switch type) Shifting up (MTB type)
A * ₁	When riding : Switch between automatic and manual gear shifting

*₁ Only enabled when the assist bicycle supports automatic gear shifting.

TECH TIPS

- When connected to the E-TUBE PROJECT, you can change the functions assigned to each switch on the switch unit. Please contact your place of purchase for details.
- Also refer to the "Switch Unit User's Manual (with LED indicator function / without LED indicator function)."

Notation method for operations

Subsequent operations of this product are indicated using the following notation.

Notation	Operation
< ↑ >	Indicates an operation for pressing the X of the assist switch.
< ↓ >	Indicates an operation for pressing the Y of the assist switch.
<A>	Indicates an operation for pressing the A of the assist switch.
[Clock] (Example) Time setting	Items displayed on the cycle computer screen are enclosed in square brackets in this manual. When this notation is used in a procedure, it indicates an operation for selecting a display on the screen with < ↑ > or < ↓ > and pressing the A of the assist switch to switch the screen or confirm the setting.

Installing and removing the cycle computer

Installing and removing the cycle computer

For the installation/removal procedure, contact your place of purchase or a distributor.

Basic operation

Turning the power ON/OFF

This product does not have a function for turning the power ON/OFF. The power of this product is linked with the main power of the assist bicycle. When the main power is turned ON, all components connected to the drive unit of the assist bicycle are also turned ON (such as assist driving, the power of this product, the electronic gear shifting mechanism, and the lights).

The main power can be turned ON/OFF using the power switch of a component included in the assist bicycle. Refer to the " SHIMANO STEPS User's Manual " or the user's manual of the component with a power switch.

NOTICE

- Before turning the power ON, please refer to the " SHIMANO STEPS Special Battery and Parts User's Manual (Gen.2) " to check the following:
 - The battery is firmly attached to the battery mount.
- The power cannot be turned ON while charging.

TECH TIPS

- If the bicycle is left unused for 10 minutes or more after turning the power ON, the power automatically turns OFF (auto power OFF function).

When the main power is turned ON, the screen shown below is displayed, then switches to the main screen.



Viewing the screen

The items displayed on the main screen differ according to the assist bicycle.

Basic operation

Viewing the screen

Main screen

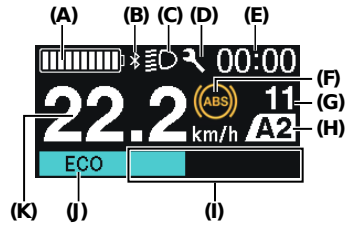

Sub screen

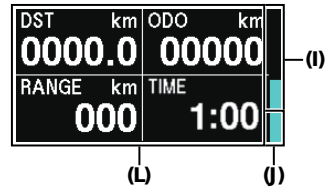

Basic operation

Viewing the screen

(A)	Battery level indicator * ₁ Displays the level of the battery mounted on the bicycle in 10 levels. Displayed in red when the level is at 10% or less.
(B)	Bluetooth® LE icon Displayed when a SHIMANO STEPS component connected with this product is communicating with an external device via Bluetooth® LE.
(C)	Light icon Displayed when the light connected to the drive unit is ON.
(D)	Maintenance alert Indicates that maintenance is required. Contact your place of purchase or a distributor if this icon is displayed.
(E)	Current time
(F)	ABS warning * ₂ For a bicycle with an ABS, indicates that ABS is not operating.
(G)	Gear position Displays the current gear position for electronic gear shifting.
(H)	Automatic / manual gear shifting * ₃ [M]: Displayed for manual gear shifting. [A1]: When two automatic gear shifting settings are registered, indicates that the product has switched to automatic gear shifting due to the first setting. When there is only one automatic gear shifting setting, indicates that the product has switched to automatic gear shifting. [A2]: When two automatic gear shifting settings are registered, indicates that the product has switched to automatic gear shifting due to the second setting.
(I)	Bar display Displays the current assist mode or the state of the output from the drive unit. Can also be displayed from the sub screen. (Refer to " Assist mode and bar display .")
(J)	Assist mode display Displays the current assist mode. On the sub screen, the assist mode is displayed using the color of the bar only. (Refer to " Assist mode and bar display .")
(K)	Current speed
(L)	Four-division display Refer to the " Switching to the sub screen " section.

*₁ This battery level display uses zero to indicate a battery level where assistance can no longer be performed. SHIMANO STEPS provides an amount of battery separate from the assist function for additional equipment such as lights and ABS. Therefore, the battery level may differ from that which can be checked with the battery LED.

*₂ For a bicycle with an ABS, ABS warning is always displayed when the power is turned ON. For information on enabling the ABS, refer to the " ABS User's Manual ."

*₃ Refer to the " SHIMANO STEPS User's Manual " for information on the operation for switching between automatic and manual gear shifting.

TECH TIPS

- For information on the sub screen, refer to “ Switching to the sub screen .”

Turning the light ON/OFF

If a light is connected to the drive unit, this product can be used to operate the light. Refer to “ Turning the light ON/OFF [Light] .”

TECH TIPS

- The light power is linked with the main power. The light cannot be turned ON when the main power is OFF.

Switching to the sub screen

This product enables up to three sub screens to be registered in addition to the main screen, and can switch between them. A sub screen is divided into four parts and can display lists of various information.

Basic operation

Switching to the sub screen

1. Press <A>

The screen switches as indicated below each time <A> is pressed.

Example: When three sub screens are registered

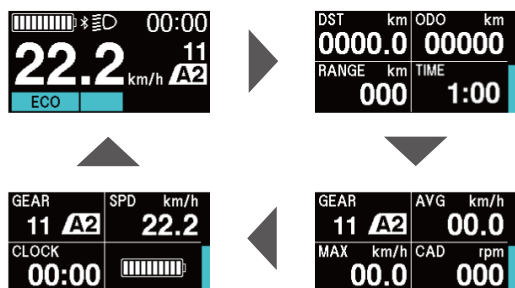

You can register sub screens in E-TUBE PROJECT and freely edit their layout. For the sub screen registration and editing procedure, contact your place of purchase.

TECH TIPS

- When the switch unit (left) is the 2-switch type, the screen can be switched by pressing < ↑ > + < ↓ > (simultaneously).
- When a component compatible with Bluetooth[®] LE is connected to your bicycle, you can register and edit sub screens in E-TUBE PROJECT Cyclist. For details, refer to the " E-TUBE PROJECT Cyclist User's Manual ."

Traveling data displayable on the sub screen

Traveling data	Explanation
[DST]	Traveling distance
[ODO]	Cumulative distance
[RANGE]	Traveling range * ₁
[TIME]	Riding time
[AVG]	Average speed
[MAX]	Maximum speed
[CAD]	Cadence
[CLOCK]	Current time
[GEAR]	Gear position and automatic / manual gear shifting
[SPD]	Current speed
[Assist Profile]	Current assist profile (Refer to " Dynamically changing the riding comfort [Assist Profile] .")
[Battery]	Battery level indicator The same as the icon displayed on the main screen.

* ₁ The value is not displayed when the assist mode is set to [OFF] or when the walk assist mode is enabled.

Setting menu

Switching to the setting menu

The items that can be set differ according to the assist bicycle. If assist switch is not connected, the setting menu cannot be displayed.

1. Stop the bicycle ⇒ <A> (continue to press and hold until the screen switches)



TECH TIPS

- You can also perform the above operation from a sub screen to switch to the setting menu.
- When the switch unit (left) is the two-switch type, E-TUBE PROJECT is required to change settings. Contact the place of purchase.

Exiting the setting menu [Exit]

When you exit the setting menu, the previous screen (the main screen or sub screen) is displayed.

1. On setting menu screen: [Exit]

Setting the time [Clock]

1. Setting menu screen ⇒ [Clock] ⇒ change the "Hour" number with <↑> or <↓> ⇒ <A>

The cursor moves to the "Minute" number.



Setting menu

Setting the time [Clock]

2. Change the "Minute" number with <↑> or <↓> ⇒ <A>

The display will automatically return to the setting menu screen.

TECH TIPS

- Continue to press and hold <↑> or <↓> to change the number quickly.

Dynamically changing the riding comfort [Assist Profile]

The riding comfort of the assist bicycle is determined by the relationship between the force applied to the pedals and the drive unit output, and the maximum output of the drive unit. This product enables you to select two assist profiles, [BASIC] and [Fine tune], that determine the riding comfort. The setting item names in [Assist Profile] and their content depend on your bicycle. In addition, by connecting to E-TUBE PROJECT, you can perform a wider range of customization than before.

1. Setting menu screen ⇒ [Assist Profile] ⇒ [BASIC] / [Fine tune]

[BASIC]

One of the following two combinations of assist modes is set by default:

- [BOOST] / [TRAIL] / [ECO]: A combination of assist modes for sport riding.
- [HIGH] / [NORMAL] / [ECO]: A combination of assist modes for comfortable riding in urban settings.

[Fine tune]

Supports a wide range of riding conditions with a maximum of 15 levels.

- The number of settings registered by default depends on the bicycle.
- The settings and gear position can be customized in E-TUBE PROJECT.

NOTICE

- Depending on the setting, battery consumption may increase and the assisted traveling range may greatly decrease.

Assist mode and bar display

When the assist mode is set to [OFF]

The assist mode display and bar display are white.

Main screen

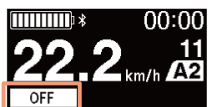

Sub screen

Setting menu

Dynamically changing the riding comfort [Assist Profile]



When the assist mode is set to the minimum level of assistance

- The assist mode display and bar display are light blue.
- With the [Fine tune] mode, the assist mode is displayed as a numeric value. For example, when 15 levels are set, 1/15 is displayed for the mode with the minimum level of assistance and 15/15 is displayed for the mode with the maximum level of assistance.

Main screen

Assist profile: [BASIC]



Assist profile: [Fine tune]



Sub screen

Assist profile: [BASIC]

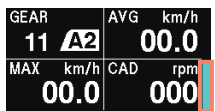

Assist profile: [Fine tune]



When the assist mode is set to the intermediate level of assistance

- The assist mode display and bar display are green.
- With the [Fine tune] mode, they are displayed in green except when the level of assistance is at the minimum or maximum.
- When two or fewer assist modes are set with the [Fine tune] mode, this color display is not available.

Main screen

Assist profile: [BASIC]

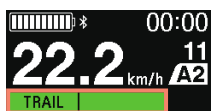

Assist profile: [Fine tune]

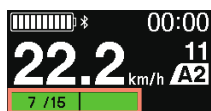

Sub screen

Assist profile: [BASIC]

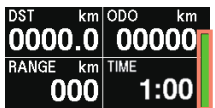

Assist profile: [Fine tune]



Setting menu

Dynamically changing the riding comfort [Assist Profile]

When the assist mode is set to the maximum level of assistance

- The assist mode display and bar display are yellow.
- When one assist mode is set with the [Fine tune] mode, yellow indicates that assist is ON.

Main screen

Assist profile: [BASIC]

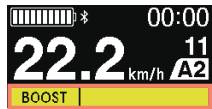

Assist profile: [Fine tune]

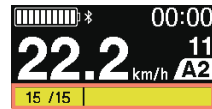

Sub screen



When the walk assist mode is set

The assist mode display and bar display are blue.

Main screen

Walk assist mode (standby)

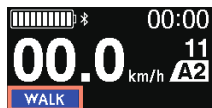

Walk assist mode (assistance functioning)



Sub screen

Walk assist mode (standby)

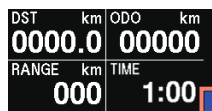

Walk assist mode (assistance functioning)

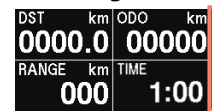

TECH TIPS

- Refer to the " SHIMANO STEPS User's Manual " for details on the walk assist mode.
- An animation with the drive unit output indicated by the length of a bar can also be displayed. The method for displaying the bar can be set with E-TUBE PROJECT.

Setting the display

Setting the screen brightness [Brightness]

1. **Setting menu screen** ⇒ **[Brightness]** ⇒ **<↑>** or **<↓>** to adjust the brightness ⇒ **<A>**

The display will automatically return to the setting menu screen.

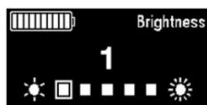

Switching the display language [Language]

1. **Setting menu screen** ⇒ **[Language]** ⇒ **select the display language** ⇒ **<A>**

The display will automatically return to the setting menu screen.

Changing the unit of the speed and distance [Unit]

Select the unit for displaying the speed and distance.

1. **Setting menu screen** ⇒ **[Unit]** ⇒ **[km] / [mile]**

The display will automatically return to the setting menu screen.

Matching the displayed speed with another device [Display speed]

You can adjust the displayed value when there is a difference between the speed displayed on this product and the speed indicator of another device.

Setting menu

Setting the assist bicycle function

1. **Setting menu screen** ⇒ **[Display speed]** ⇒ **<↑>** or **<↓>** to adjust the value ⇒ **<A>**

The display will automatically return to the setting menu screen.



Increase value

Increases the displayed speed value.

Decrease value

Decreases the displayed speed value.

TECH TIPS

- This setting only changes the displayed value. It does not change the power assist function.

Resetting the traveling distance [Clear]

Resets the traveling distance. When the traveling distance is reset, [TIME] (riding time), [AVG] (average speed), and [MAX] (maximum speed) will also be reset.

1. **Setting menu screen** ⇒ **[Clear]** ⇒ **[DST]** ⇒ **[OK]**

The display will automatically return to the setting menu screen.

Setting the assist bicycle function

Turning the light ON/OFF [Light]

Turns the light connected to the drive unit ON/OFF.

1. **Setting menu screen** ⇒ **[Light]** ⇒ **[ON]** / **[OFF]**

The display will automatically return to the setting menu screen.

Setting the gear position when starting from a stop [Start mode]

Automatically shifts to the set gear position when the bicycle starts from a stop. [Start mode] can only be set when the bicycle has a Di2 internal geared hub.

Setting menu

Setting the assist bicycle function

1. **Setting menu screen** ⇒ **[Start mode]** ⇒ **< ↑ >** or **< ↓ >** to select the gear position ⇒ **<A>**

The display will automatically return to the setting menu.



[OFF]

Do not set the start mode.

[1], [2], ...

Select the gear position when starting from a stop. A gear position up to the maximum gear position of the shifting unit installed to the assist bicycle can be selected.

TECH TIPS

- [Start mode] can also be set for manual gear shifting.
- [Start mode] can only be set to [OFF] for manual gear shifting.
- This setting overwrites the automatic gear shifting settings configured at the time of purchase. It can be set when switched to [M], [A1] or [A2].

Adjusting automatic gear shifting [Shift timing]

Adjusts the gear shifting timing during automatic gear shifting.

Setting menu

Setting the assist bicycle function

1. **Setting menu screen** ⇒ **[Shift timing]** ⇒ **<↑>** or **<↓>** to adjust the value ⇒ **<A>**

The display will automatically return to the setting menu.



Increase value

Increase the value when pedaling feels too heavy.

Decrease value

Decrease the value when pedaling feels too light.

TECH TIPS

- This setting overwrites the automatic gear shifting settings configured at the time of purchase. It can be set when switched to [A1] or [A2].

Troubleshooting

Gear shifting adjustment with the electronic gear shifting unit [Adjust]

If gear shifting feels abnormal, contact the place of purchase.

When gear shifting is impossible

If you are unable to change gears using the electronic gear shifting, check the cycle computer display for the following. Also refer to " Error/warning indication ."

When [Adjust] is displayed

The system has switched to adjustment mode. Perform the following operations to cancel it.

1. < ↑ >< ↓ > (select [Cancel]) ⇒ <A>

The system returns to the setting menu screen.



2. On setting menu screen: [Exit]

The system returns to the main screen or sub screen, and gear shifting is available.

Error/warning indication

Error indication

If an error code "E***" (where *** is letters or numbers) is displayed on the entire screen, the product may have malfunctioned.

Even when the setting screen or sub screen is displayed, the error code is displayed on the entire screen if an error occurs.

Refer to the " SHIMANO STEPS Special Battery and Parts User's Manual " and follow one of the procedures below to reset the display:

- Press the battery power button to turn the power OFF.

Troubleshooting

When a problem occurs

- Remove the battery from the battery mount.



NOTICE

- If the situation does not improve even after turning the power back ON, stop using the bicycle and consult with the place of purchase or a distributor as soon as possible.

Warning indication

If a warning code “W***” (where *** is letters or numbers) is displayed on the screen, the product may have a temporary problem. Functionality may be limited while the code is displayed.

If the situation is improved, this indication will disappear. If the situation does not improve, contact the place of purchase as soon as possible.



For details on error/warning codes, check the latest versions below:



<https://si.shimano.com/error>

When a problem occurs

The FAQ for the SHIMANO STEPS series can be accessed with the following:



<https://bike.shimano.com/faq/STP0A>

SHIMANO



SHIMANO NORTH AMERICA BICYCLE, INC.
One Holland, Irvine, California 92618, U.S.A. Phone: +1-949-951-5003

SHIMANO EUROPE B.V.
High Tech Campus 92, 5656 AG Eindhoven, The Netherlands Phone: +31-402-612222

MADISON (A DIVISION OF H.YOUNG (OPERATIONS) LTD)
Roebuck Way, Knowlhill, Milton Keynes, Buckinghamshire, MK5 8HL, United Kingdom

SHIMANO INC.
3-77 Oimatsu-cho, Sakai-ku, Sakai City, Osaka 590-8577, Japan